

## ASSEMBLY INSTRUCTIONS

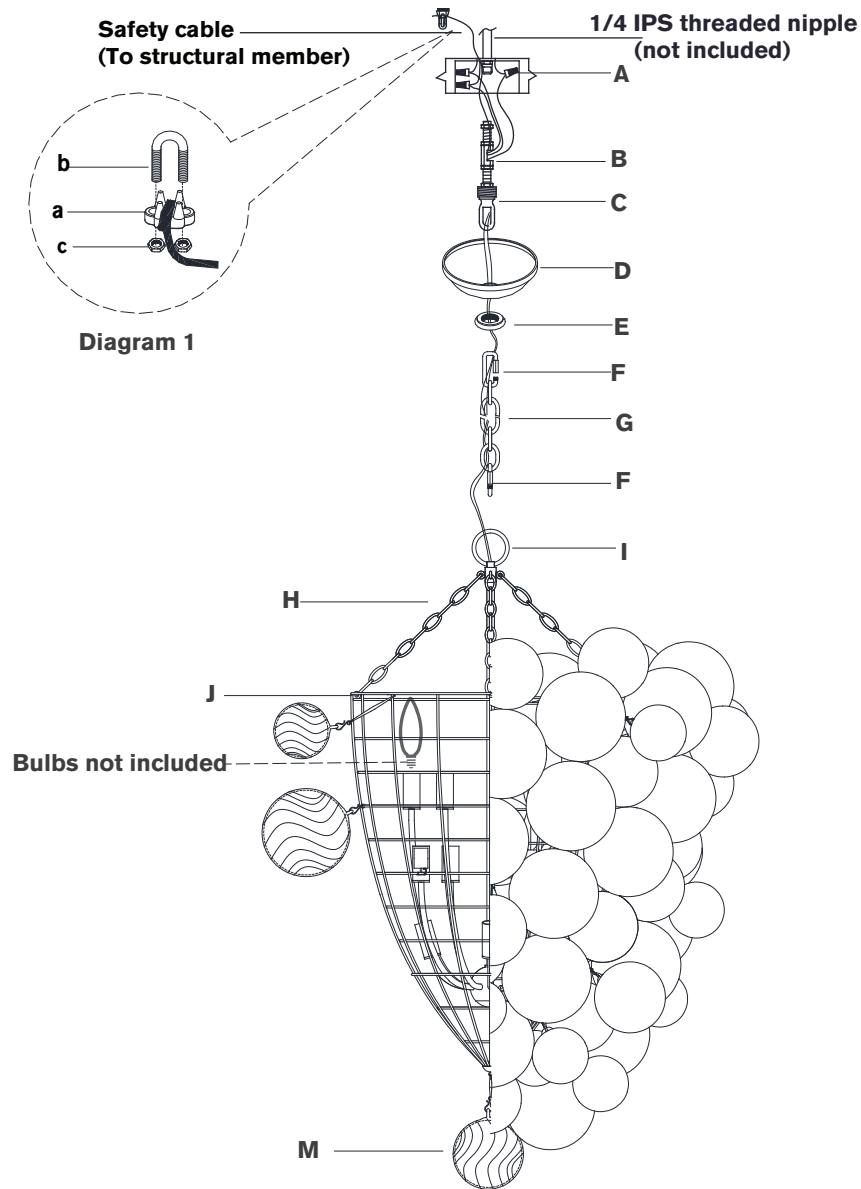

## Talia Grande Entry Chandelier

Item # JN 5114

### NOTICE:

This light fixture should be installed in accordance with all applicable, local installation codes, and by a person familiar with the construction and operation of it, as well as the hazards involved. Inspect item and contents carefully. If any damage or defect is found, do not install. Retain all packaging material until installation is complete and approved.

### TOOLS REQUIRED (NOT INCLUDED):

Phillips Screwdriver	Slotted Screwdriver	Chain Pliers
Slip Joint Pliers	Measuring Tape	Wire Cutters
Wire Strippers		

- Carefully remove all parts from the box. Place on a clean, soft surface.
- It is recommended to install a 1/4 IPS (1/2" dia) threaded pipe, secured to a structural member of the building (not included). Then install threaded receiver **(B)** on top of fixture to threaded pipe and tighten with wrench.  
**NOTE:** Item must be supported independent of the junction box due to hanging weight.
- Remove collar loop **(C)** from chain **(G)** and secure to threaded receiver attached to structural member by tightening locknut.
- Install canopy **(D)** to collar loop **(C)** and secure with collar ring **(E)**.
- Determine desired overall length, and amount of chain **(G)** needed. Shorten chain using chain pliers. (Keep extra chain)
- Attach chain **(G)** to collar loop **(C)** and fixture loop **(I)** using quick links **(F)**. Secure quick links **(F)**.
- Attach chains **(H)** to hooks on fixture body **(J)** and hooks on the bottom of fixture loop **(I)**.
- Thread fixture wire and ground wire through chain **(H)** and chain **(G)**.  
**NOTE:** When you reach the collar loop **(C)**, ensure there is no tension on the wires. Cut excess wires, being sure to leave about **12"** to reach the junction box.

## ASSEMBLY INSTRUCTIONS

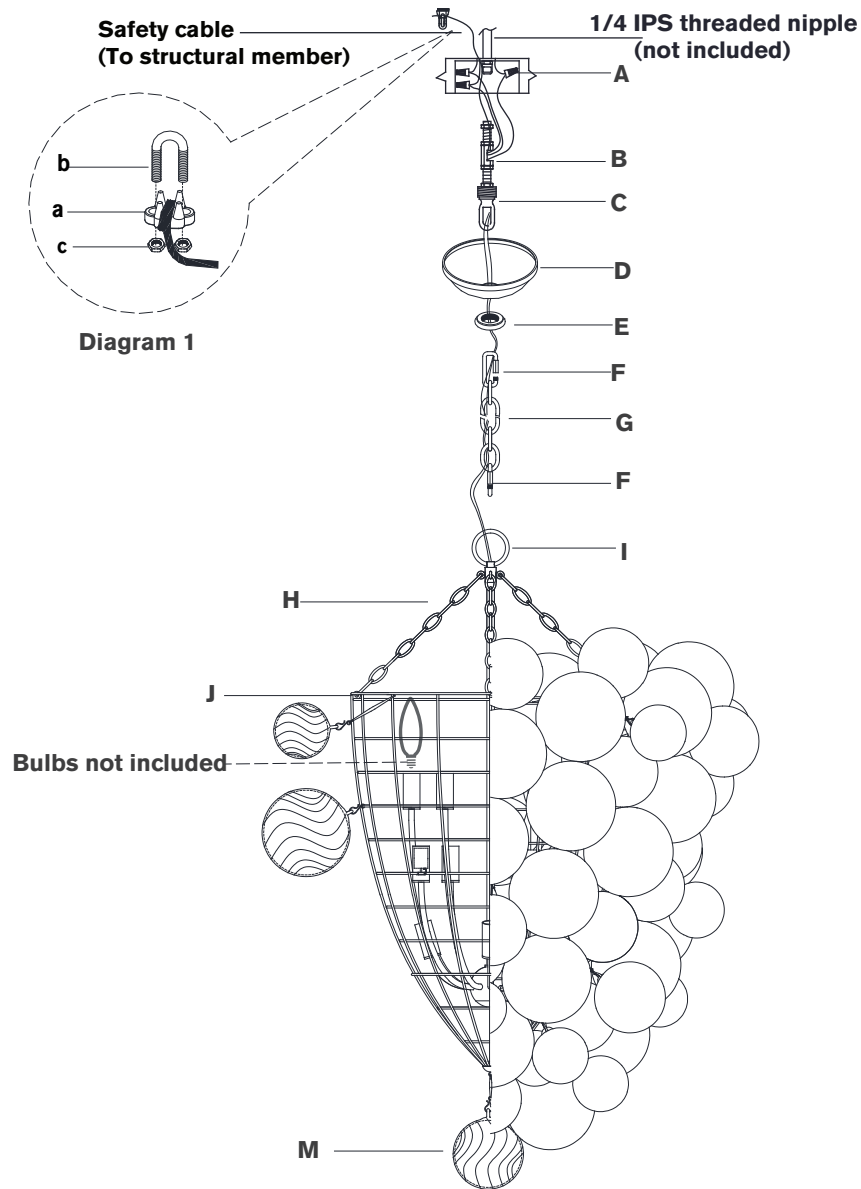

## Talia Grande Entry Chandelier

Item # JN 5114

### NOTICE:

This light fixture should be installed in accordance with all applicable, local installation codes, and by a person familiar with the construction and operation of it, as well as the hazards involved. Inspect item and contents carefully. If any damage or defect is found, do not install. Retain all packaging material until installation is complete and approved.

9. Separate two sides of molded wire, and strip insulation on each 5/8".
10. Loosen collar ring **(E)** and let canopy **(D)** slip down chain **(G)** carefully.
11. Twist all fixture wires together. Slip through center hole of collar loop **(C)**.  
**NOTE:** Untwist wires and separate to prepare for connection.
12. Run safety cable through junction box and around structural member of building. Wrap the safety cable around the saddle **(a)**, and secure with u-bolt **(b)** and hex nuts **(c)**. (See diagram 1)
13. Continue fixture ground wire and connect to supply ground wire (usually green or bare copper) using wire nut **(A)**.  
**NOTE:** It is imperative that the fixture is grounded.
14. Connect fixture neutral wire (ribbed) to the supply neutral wire (usually white) using wire nut **(A)**.
15. Connect fixture hot wire (smooth with markings) to the supply hot wire (usually black) using wire nut **(A)**.  
**CAUTION:** Do not reverse the hot and neutral connections.
16. Make sure all wire connections are tight, then carefully tuck into the junction box.
17. Install canopy **(D)** to collar loop **(C)** and secure with collar ring **(E)**.
18. Insert light bulbs into the sockets.
19. Install glass ball **(M)** to the bottom of fixture frame.

## ASSEMBLY INSTRUCTIONS

## Talia Grande Entry Chandelier

Item # JN 5114

### NOTICE:

This light fixture should be installed in accordance with all applicable, local installation codes, and by a person familiar with the construction and operation of it, as well as the hazards involved. Inspect item and contents carefully. If any damage or defect is found, do not install. Retain all packaging material until installation is complete and approved.

20. Install glass balls starting from bottom (layer 12) and working your way to the top (layer 1) as shown in figures L12-L1.

**Care Instructions:** Clean only with a soft dry cloth or feather duster. Do not use abrasive or chemical agents.

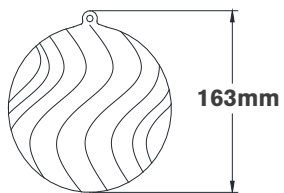
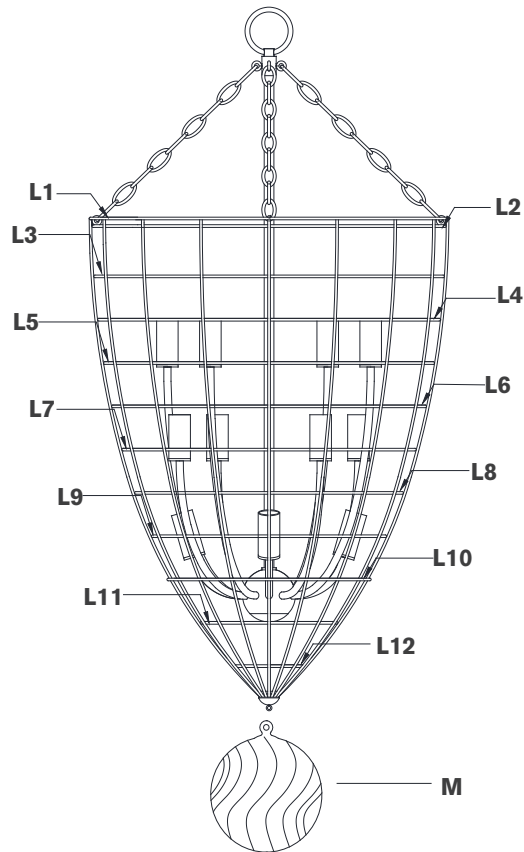

L 46pcs  
+ 2pcs spare parts

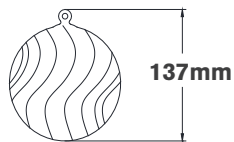

M 35pcs  
+ 2pc spare parts

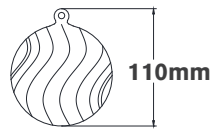

S 26pcs  
+ 2pcs spare parts

VISUAL COMFORT



# ASSEMBLY INSTRUCTIONS

## Talia Grande Entry Chandelier

Item # JN 5114

### NOTICE:

This light fixture should be installed in accordance with all applicable, local installation codes, and by a person familiar with the construction and operation of it, as well as the hazards involved. Inspect item and contents carefully. If any damage or defect is found, do not install. Retain all packaging material until installation is complete and approved.

L12

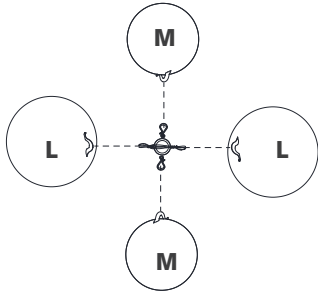

L11

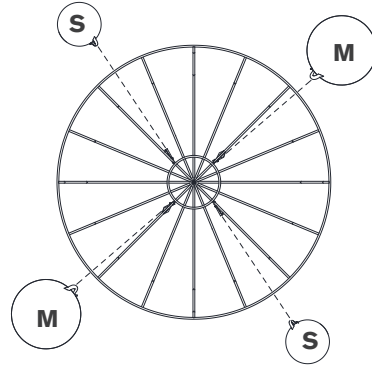

L9

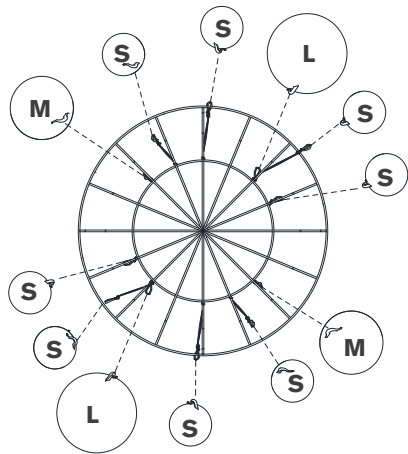

L10

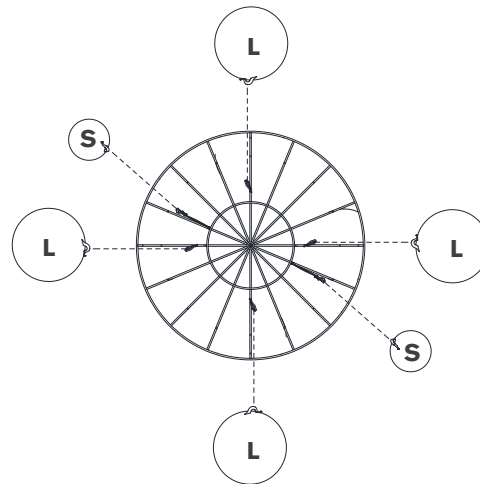

## ASSEMBLY INSTRUCTIONS

L8

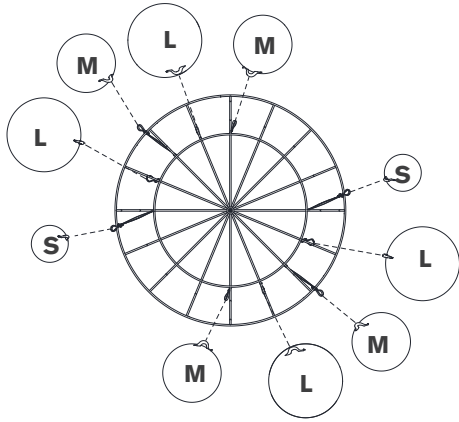

L7

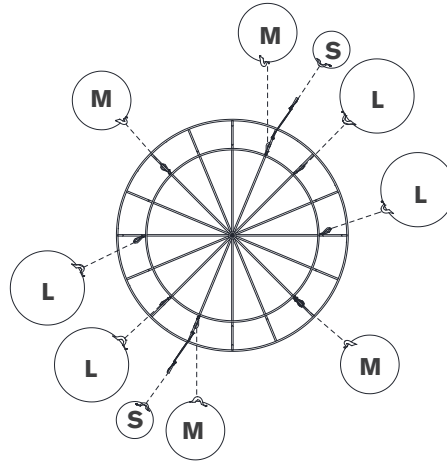

L6

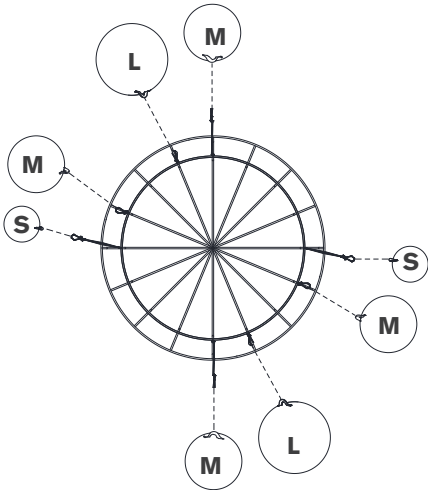

L5

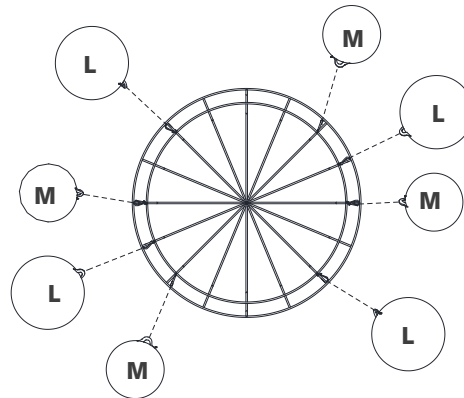

## Talia Grande Entry Chandelier

Item # JN 5114

### NOTICE:

This light fixture should be installed in accordance with all applicable, local installation codes, and by a person familiar with the construction and operation of it, as well as the hazards involved. Inspect item and contents carefully. If any damage or defect is found, do not install. Retain all packaging material until installation is complete and approved.

## ASSEMBLY INSTRUCTIONS

## Talia Grande Entry Chandelier

Item # JN 5114

### NOTICE:

This light fixture should be installed in accordance with all applicable, local installation codes, and by a person familiar with the construction and operation of it, as well as the hazards involved. Inspect item and contents carefully. If any damage or defect is found, do not install. Retain all packaging material until installation is complete and approved.

L4

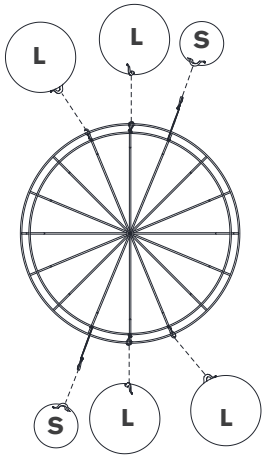

L3

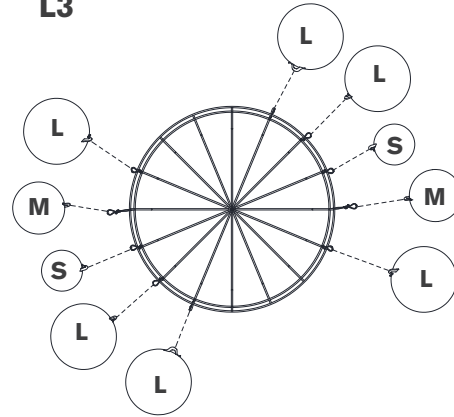

L2

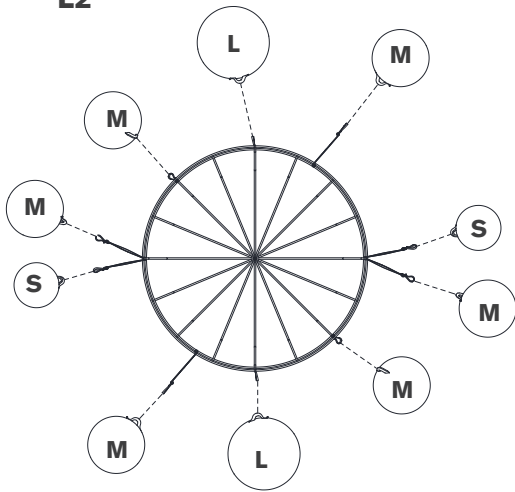

L1

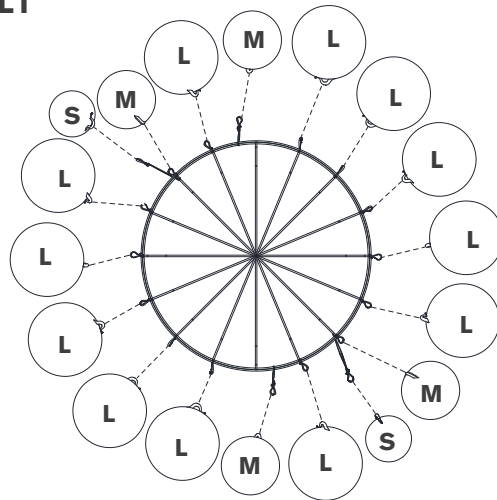

VISUAL COMFORT

